

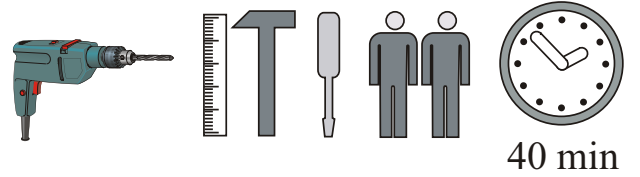

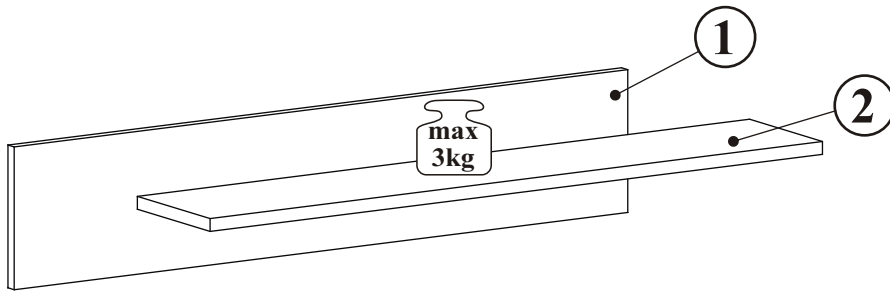

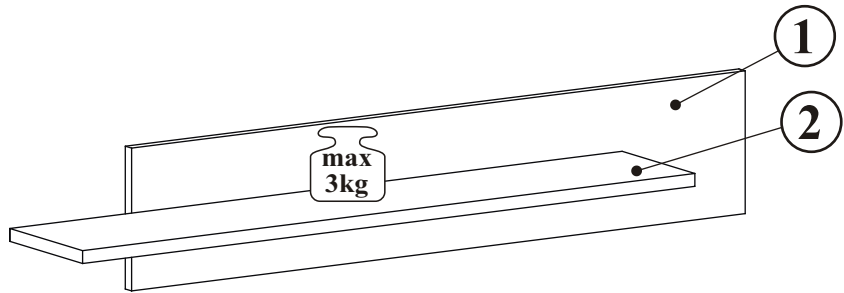

POINT 23_MX

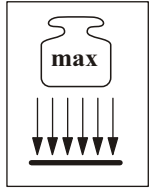
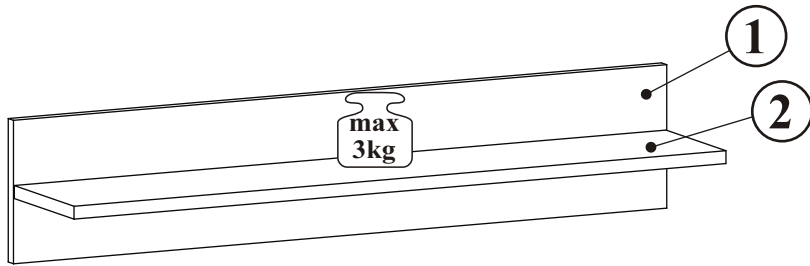
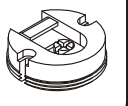

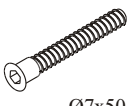
NO	Dim.		Col.-No	Qty
1	1002	200	1	2
2	1000	185	1	2

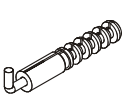
POINT 23_MX

ZM1 x4		D20 x8	 ESØ6x9,5	B11 x12	 Ø7x50	G4 x12		KR2 x4		G2 x1	
-----------	---	-----------	---	------------	--	-----------	---	-----------	---	----------	---

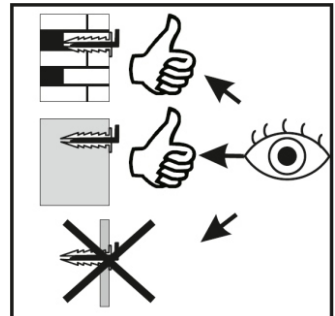
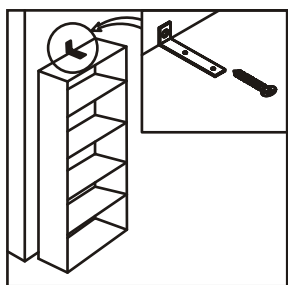
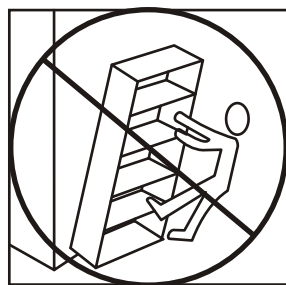
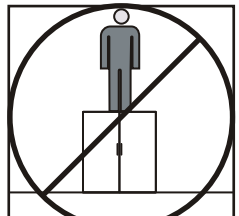
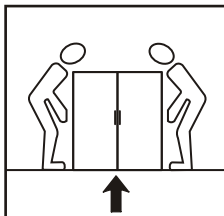
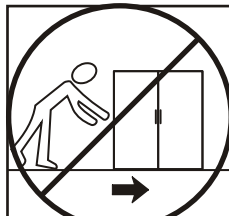
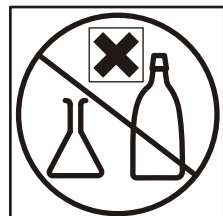
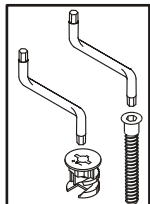
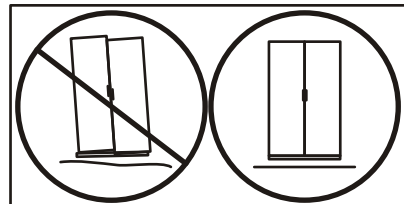
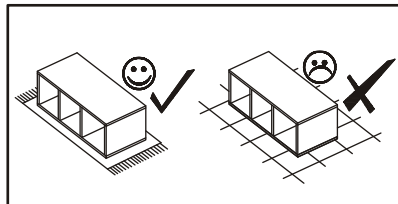
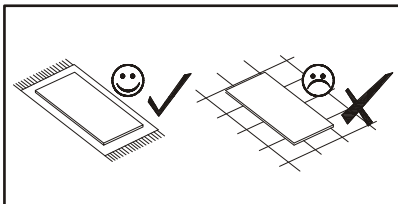
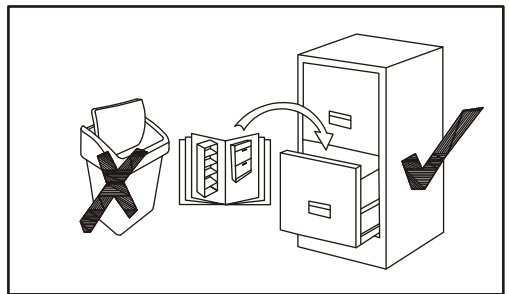
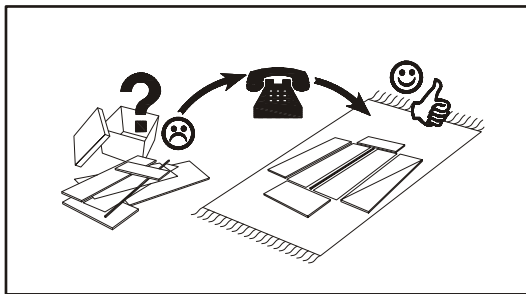
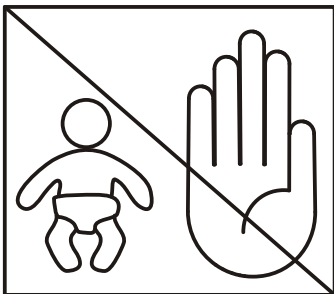
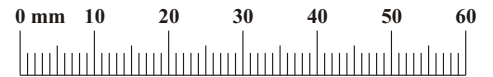

1-3

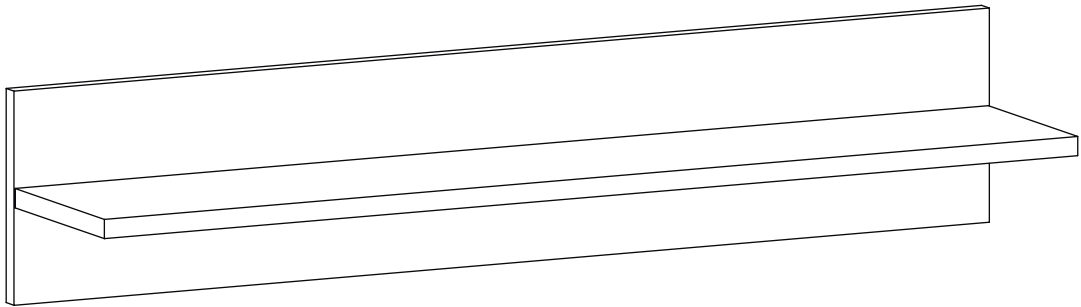

4-6

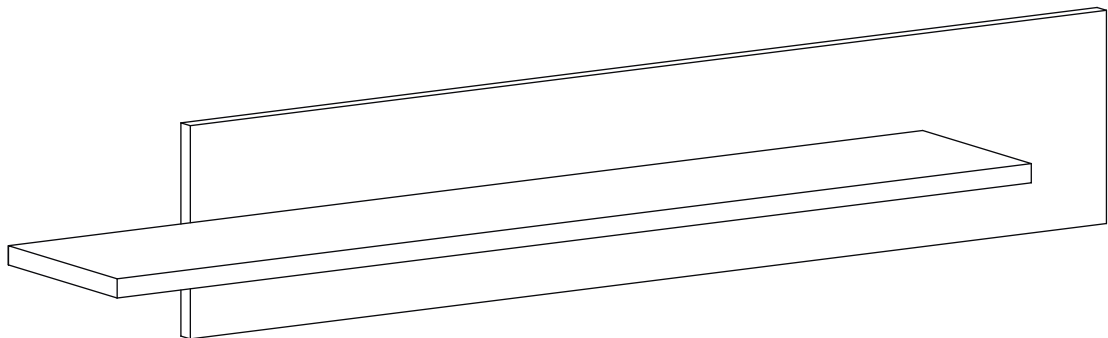

7-9

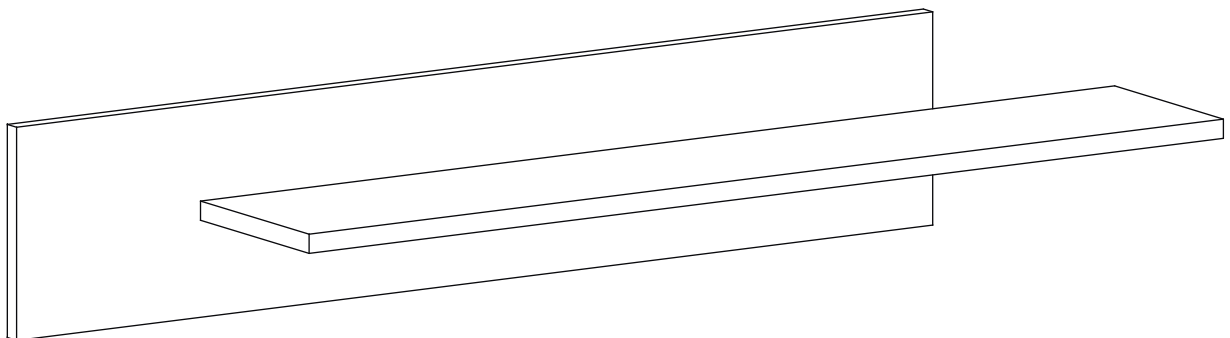

POINT 23_MX

1

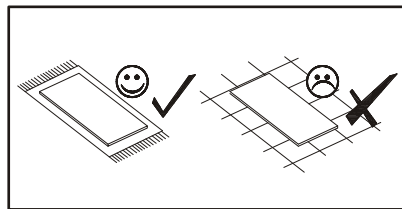

ZM1

x4



D20

x8



ES06x9,5

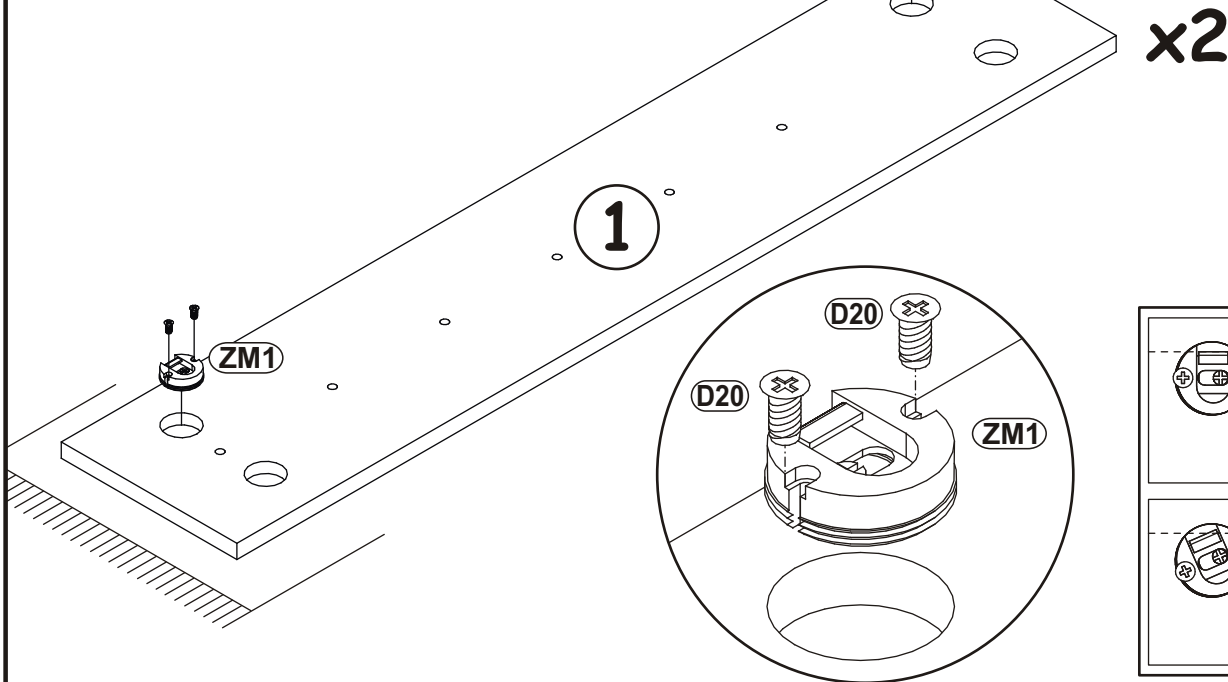

2

B11

x12

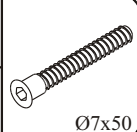

Ø7x50

G4

x12

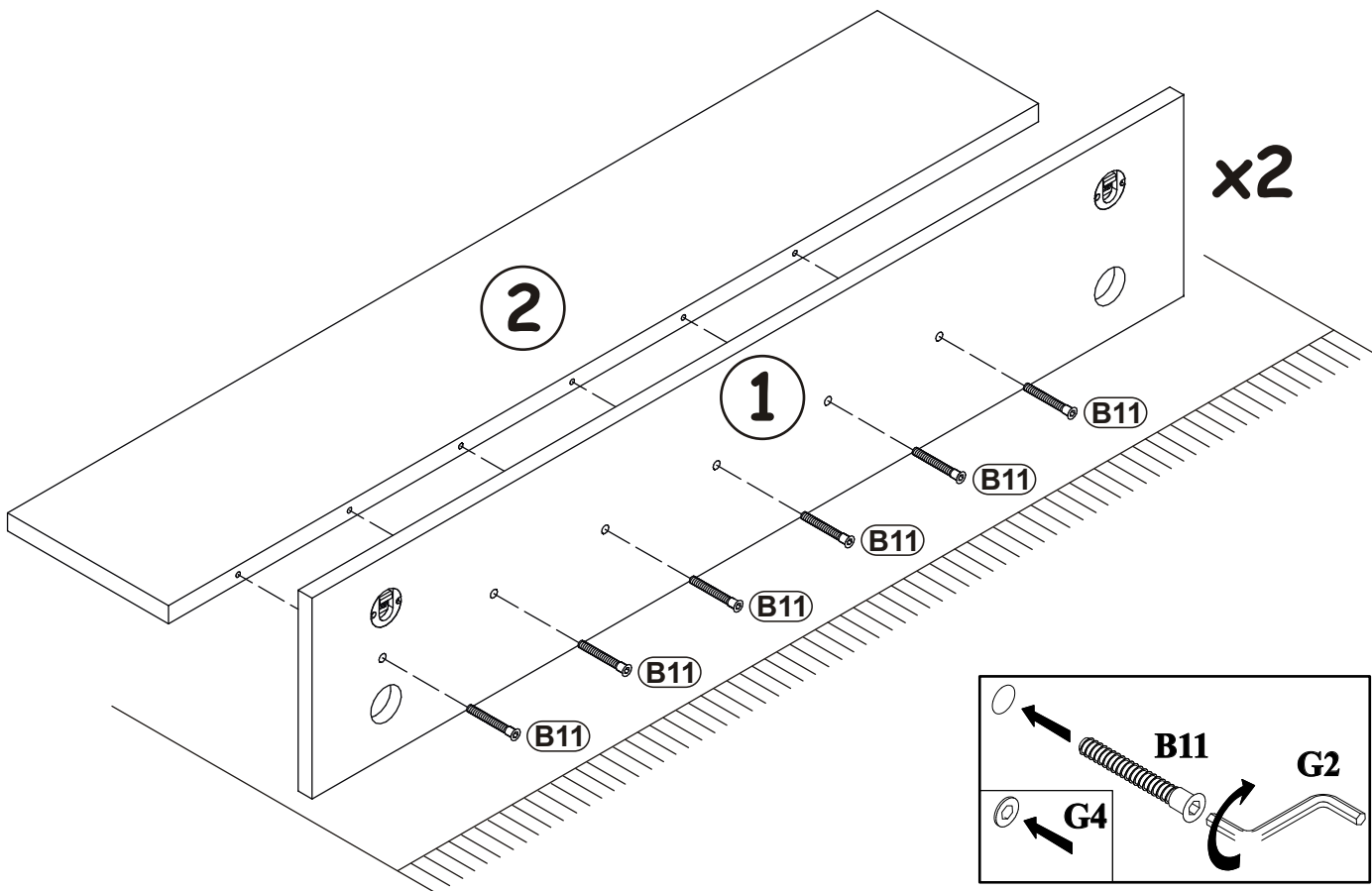

3

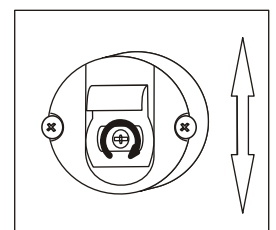
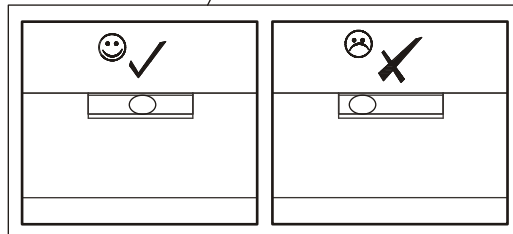
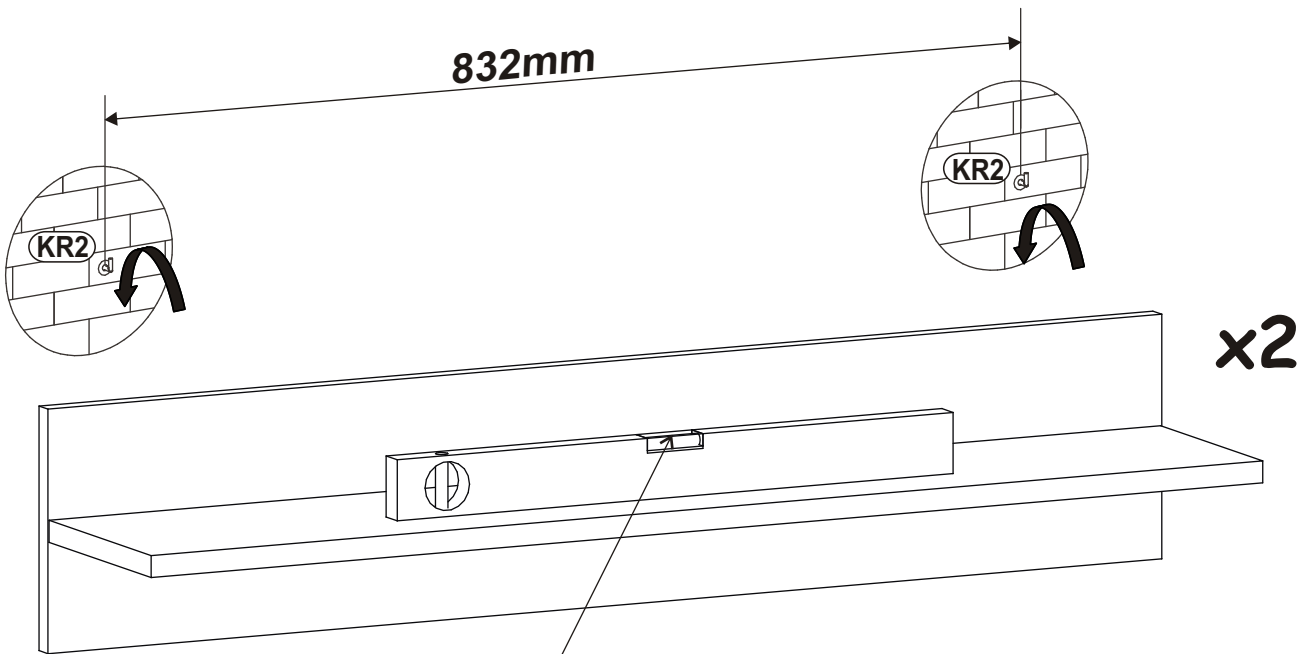
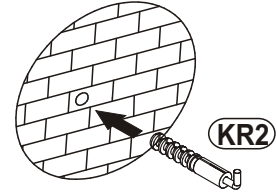
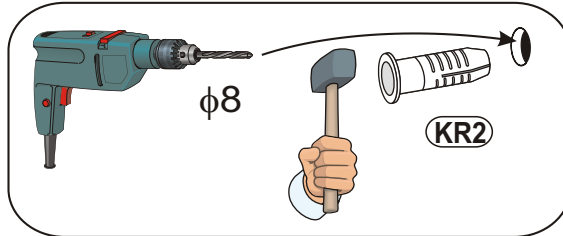
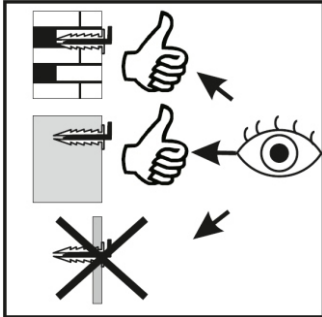
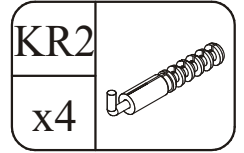

POINT 23_MX

4

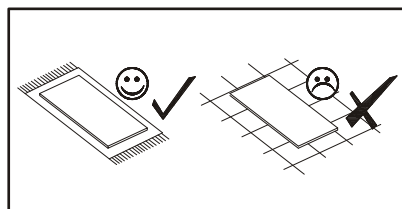

ZM1	
x4	

D20	
x8	ES06x9,5

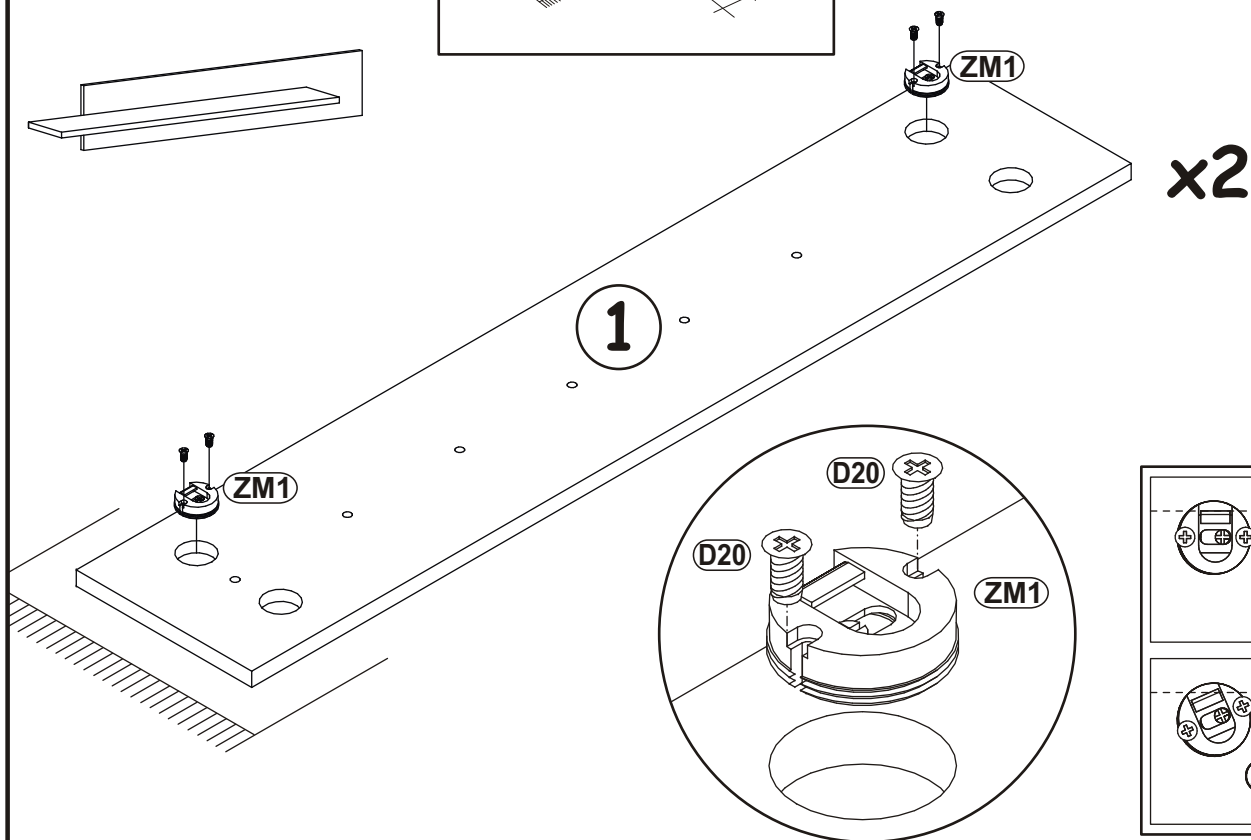

5

B11		G4	
x12	Ø7x50	x12	

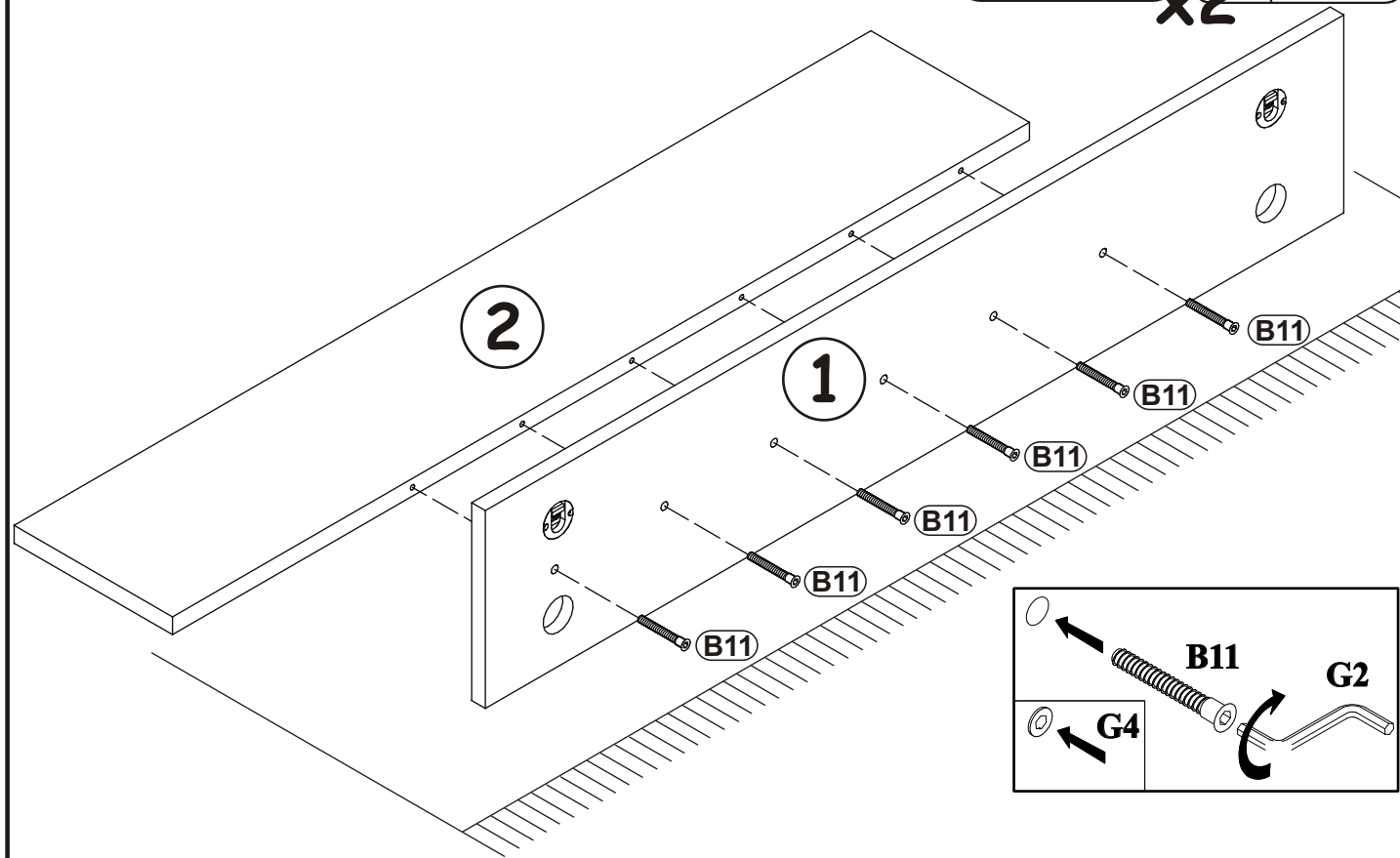

6

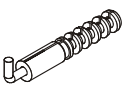
KR2	
x4	

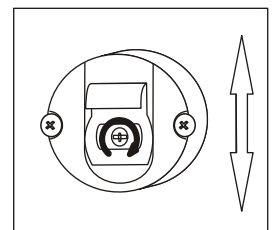
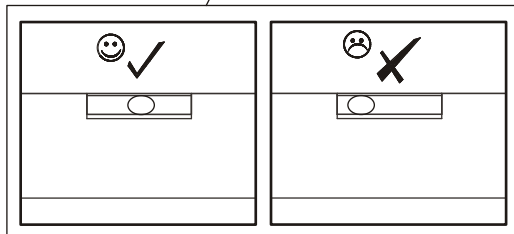
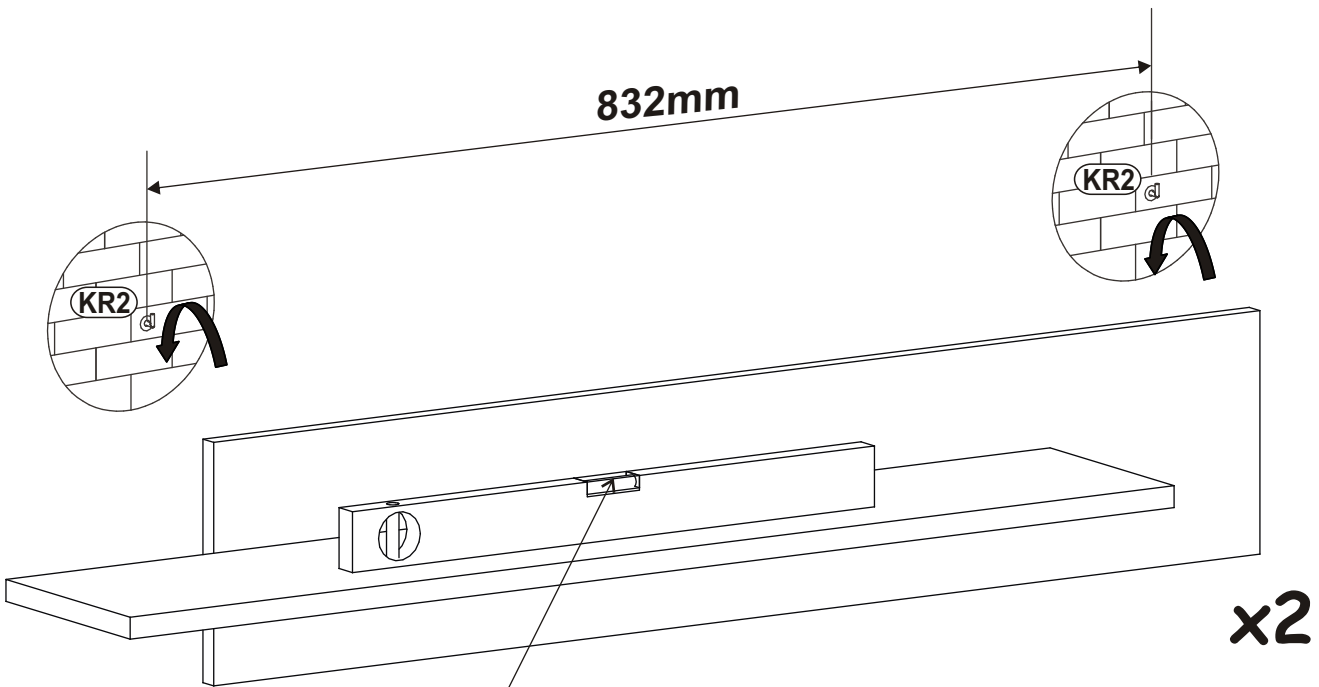
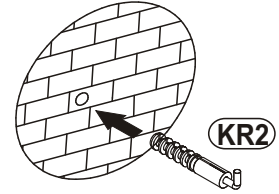
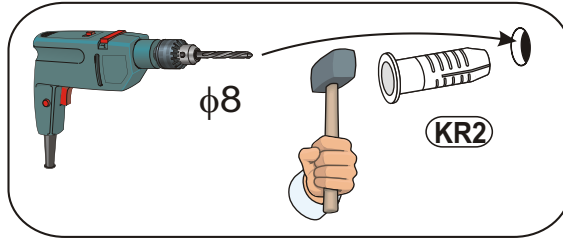
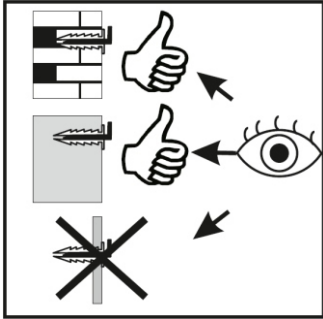
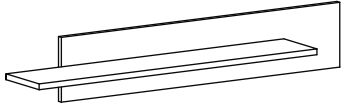

POINT 23_MX

7

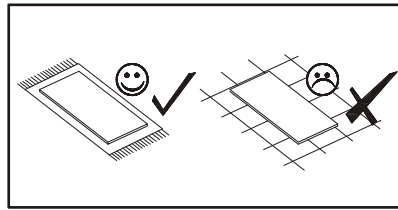

ZM1

x4

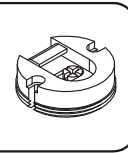

D20

x8



ES06x9,5

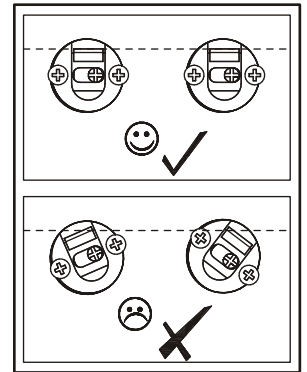
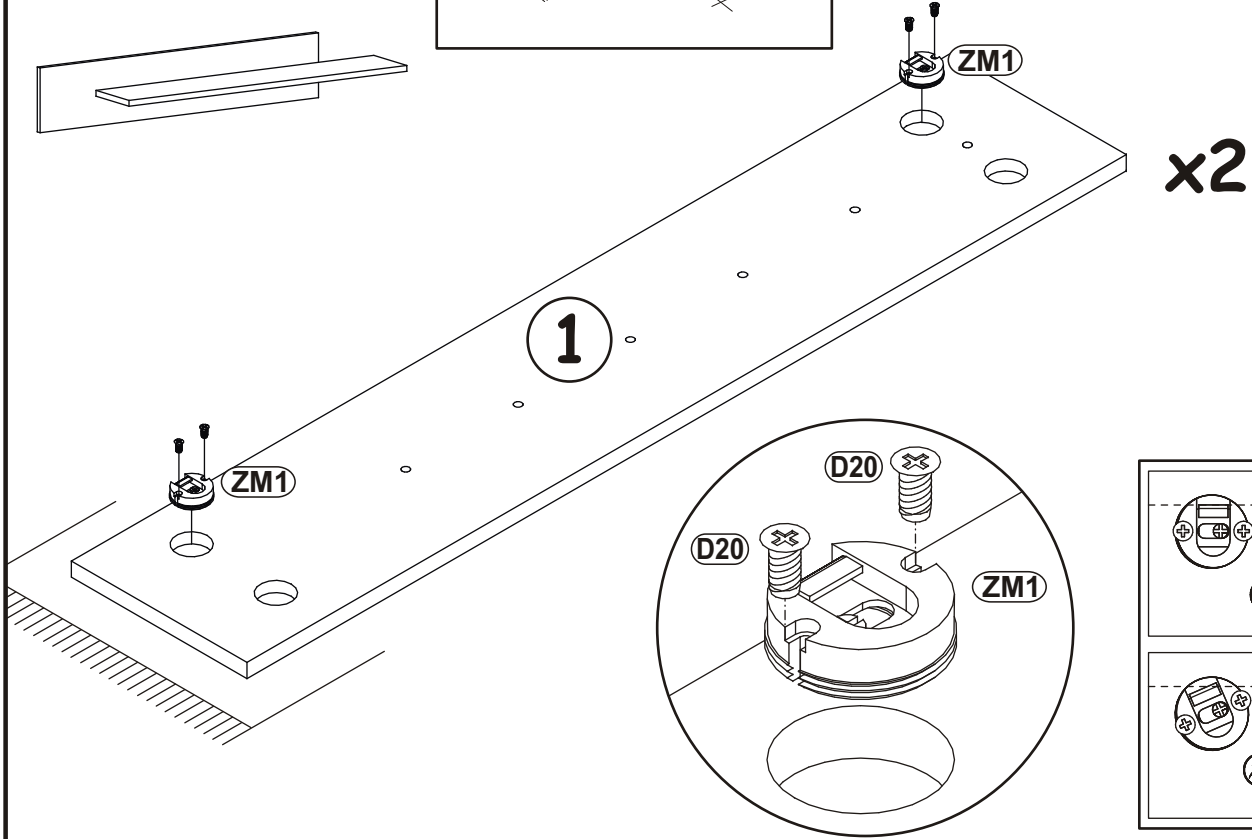

8

B11

x12

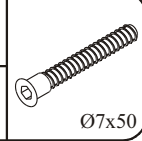

Ø7x50

G4

x12

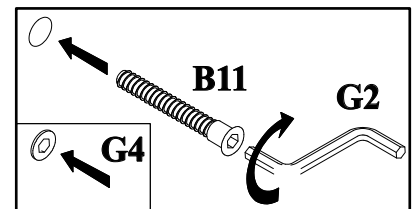
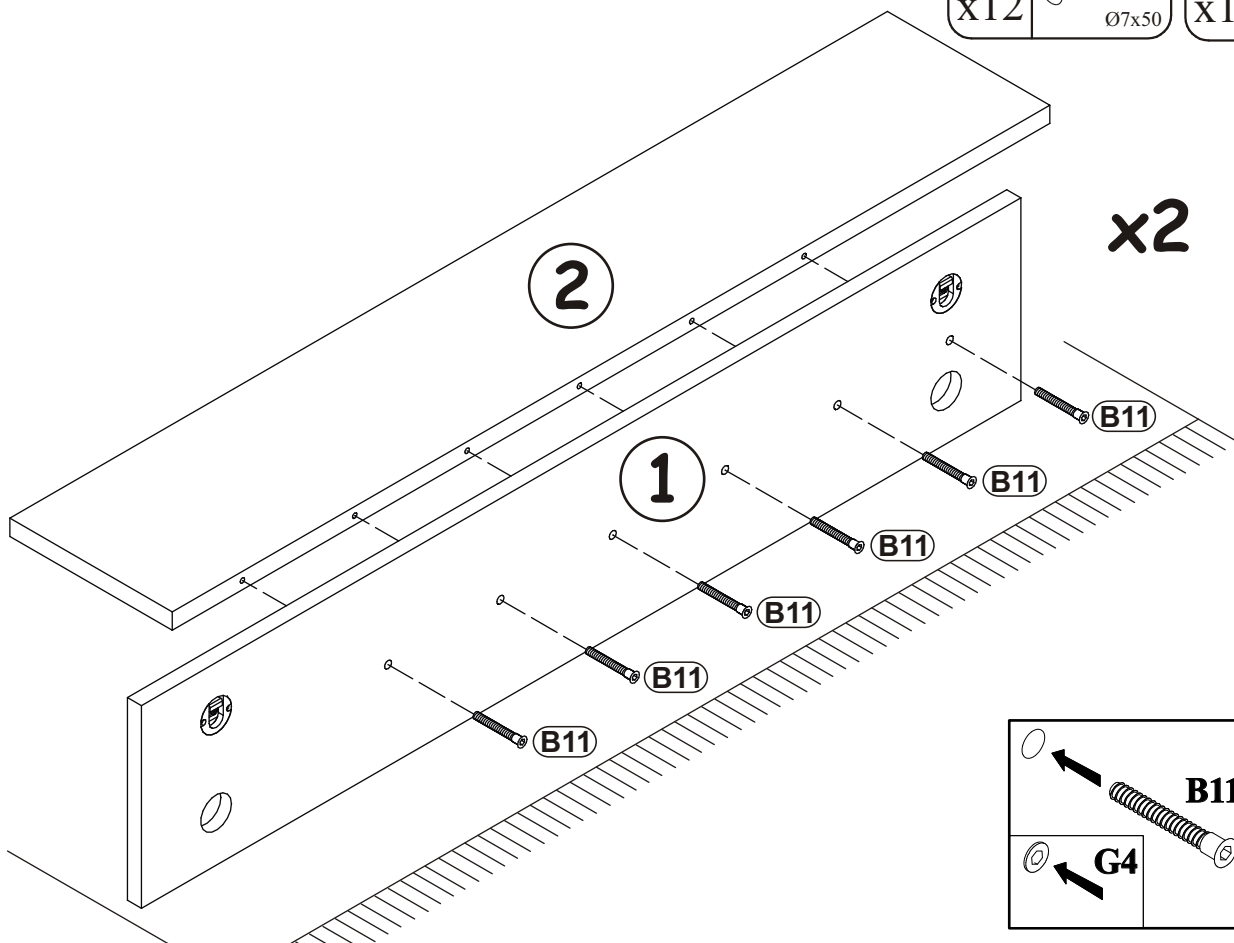
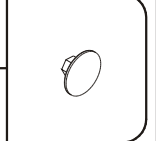

9

